

# 04-136 - 316270600001/ 5451 - 316268600001 / 04-162 -316269600001

**ATTENTION : (pour connaître les caractéristiques d'utilisation consulter la carte grise).**

Installé suivant nos recommandations, cet attelage vous donnera entière satisfaction. Nous dégageons toute responsabilité en cas de transformation ou d'utilisation illicite de celui-ci

**FR**

**ACHTUNG: (Nutzungsmerkmale : siehe Fahrzeugschein)**

Diese Anhängervorrichtung wird Sie voll zufrieden stellen, wenn Sie unsere Montageanleitung befolgen. Im Falle der unerlaubten Veränderung oder des unerlaubten Gebrauchs lehnen wir jede Haftung ab.

**DE**

**PLEASE NOTE : (to familiarise yourself with the operating characteristics refer to the log).**

If this tow bar is fitted in accordance with our recommendations it will give a completely satisfaction. We cannot accept any responsibility in the event of changes to or improper use of this item.

**EN**

**BEMÆRK : (for yderligere oplysninger om anvendelsesforhold henvises der til registreringsattesten)**

Hvis dette anhængertræk monteres i henhold til vores anvisninger, vil det være til din fulde tilfredshed. Vi fralægger os ethvert ansvar ved ulovlig ændring eller brug af anhængertrækket.

**DA**

**ΠΡΟΣΟΧΗ : (για να πληροφορηθείτε τα χαρακτηριστικά χρήσης συμβουλευτείτε την γκριζα κάρτα)**

Εγκατεστημένο σύμφωνα με τις συστάσεις μας, αυτό το σύστημα ρυμούλκησης θα σας ικανοποιήσει πλήρως. Απεκδυόμεθα πάσης ευθύνης σε περίπτωση μετατροπής ή παράνομης χρήσης αυτού.

**EL**

**ATENCIÓN: (para conocer las características de utilización, consultar el permiso de circulación)**

Instalado siguiendo nuestras recomendaciones, este enganche le dará total satisfacción. No asumiremos ninguna responsabilidad en caso de que haya sido transformado o utilizado ilícitamente.

**ES**

**UWAGA (charakterystyki użytkowania należy sprawdzić w dowodzie rejestracyjnym)**

Dyszel holowniczy będzie funkcjonował we właściwy sposób po zainstalowaniu go zgodnie z zaleceniami. Nie ponosimy żadnej odpowiedzialności w przypadku wprowadzenia zmian lub niedozwolonego użycia

**PL**

**HUOMIO: (käyttöominaisuuksiin tutustumiseksi on katsottava rekisteriotetta)**

Suosituksen mukaan asennettuna tämä vetokoukku täyttää odotuksesi.

Emme ota vastuuta, jos laitetta muutetaan tai käytetään ohjeiden vastaisesti.

**FI**

**ATTENZIONE : (per conoscere le caratteristiche d'uso consultare il libretto di ircolazione)**

Installato seguendo le nostre raccomandazioni, questo gancio da traino vi lascerà completamente soddisfatti. Respingiamo ogni responsabilità in caso di trasformazione o utilizzo illecito dello stesso.

**IT**

**LET OP : (voor gebruikskennmerken het kentekenbewijs raadplegen)**

Indien u de koppeling volgens onze aanbevelingen heeft geïnstalleerd, zal het u tot volle tevredenheid stemmen. Wij stellen ons niet aansprakelijk in geval van wijziging of onrechtmatig gebruik.

**NL**

**ADVARSEL: (for kunnskap om bruksegenskapene, se vognkortet)**

Ved å installere innretningen i samsvar med våre anbefalinger vil du få maksimalt utbytte av dette tilhengerfestet. Vi fraskriver oss alt ansvar hvis tilhengerfestet endres eller brukes på ulovlig måte.

**NO**

**POZOR: (užívateľské charakteristiky naleznete v technickém průkazu)**

Tažné zařízení instalované dle našich doporučení vás plně uspokojí. V případě představby nebo neoprávněného užívání se zbavujeme veškeré odpovědnosti

**CZ**

**VARNING: (Läs igenom registreringsbeviset för att ta reda på rådande användningsvillkor)**

Om du monterar produkten enligt våra anvisningar kommer du uppnå bästa möjliga resultat. Vi avsägar oss allt ansvar i de fall kunden inte följt våra anvisningar fullt ut.

**SV**

**FIGYELEM : (a használati jellegzetességeket a forgalmi engedélyből ismerheti meg)**

A vonóhorog előírásainknak megfelelő felszerelés esetén a terméket teljes elégedettséggel használhatja. A termék átalakítása vagy tiltott használata esetén semmilyen felelősséget nem vállalunk.

**HU**

**ВНИМАНИЕ : (чтобы ознакомиться с рабочими характеристиками, изучите технический паспорт автомашины)**

Установленное при соблюдении рекомендаций, данное тягово-сцепное устройство в полной мере удовлетворит ваши потребности. Производитель не несет никакой ответственности в случае деформации или

**RU**



**SIARR**

**04 - 136**

**5451**

**WESTFALIA**

**31627060001**

**31626860001**

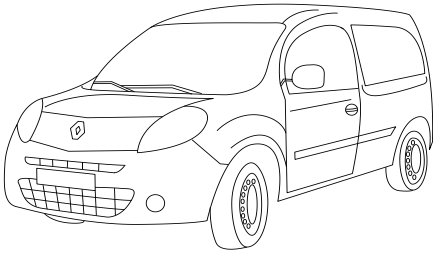

**KANGOO II - CITAN  
SI069**



1 350 kg



75 kg

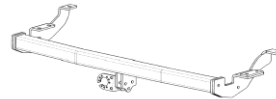

23 kg

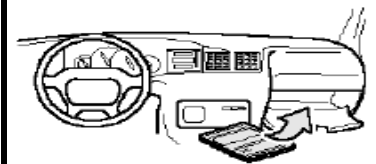

e24\*94/20\*0103\*01



2 200 kg

0 Km



1000 Km

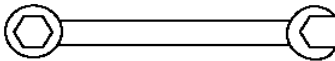

8,20 kN

**04 - 136**

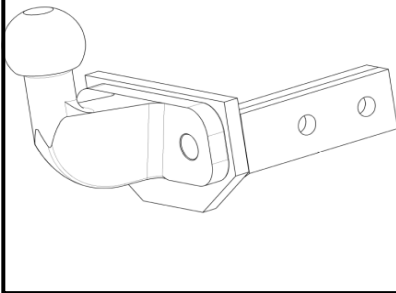

**5451**

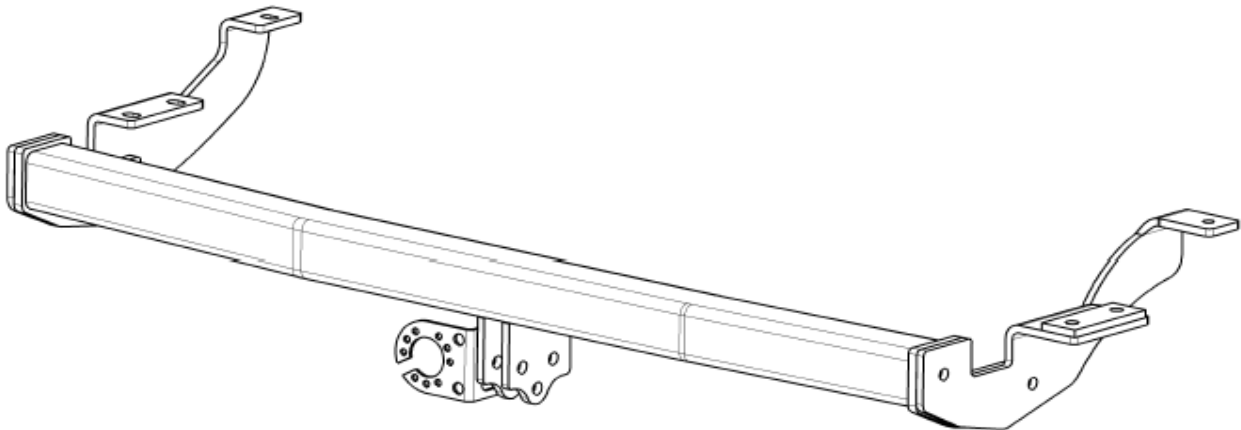
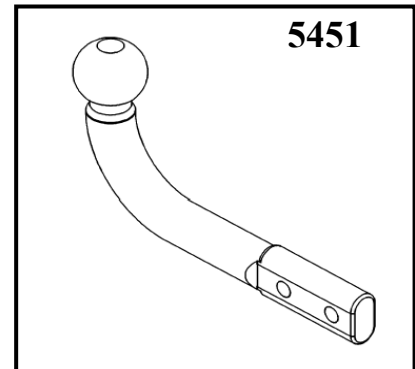



SIARR

04 - 162

WESTFALIA

31626960001

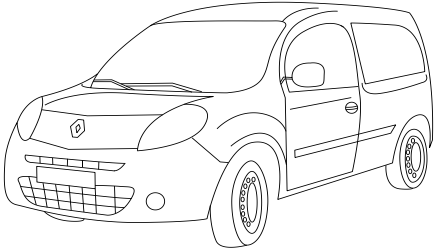

KANGOO II - CITAN  
SI070



1 350 kg



75 kg

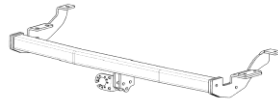

23 kg

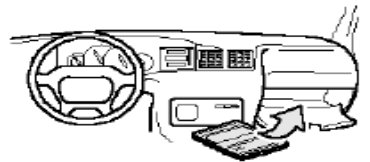

e24\*94/20\*0112\*01



2 200 kg

0 Km



1000 Km

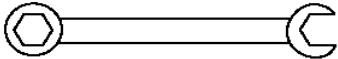





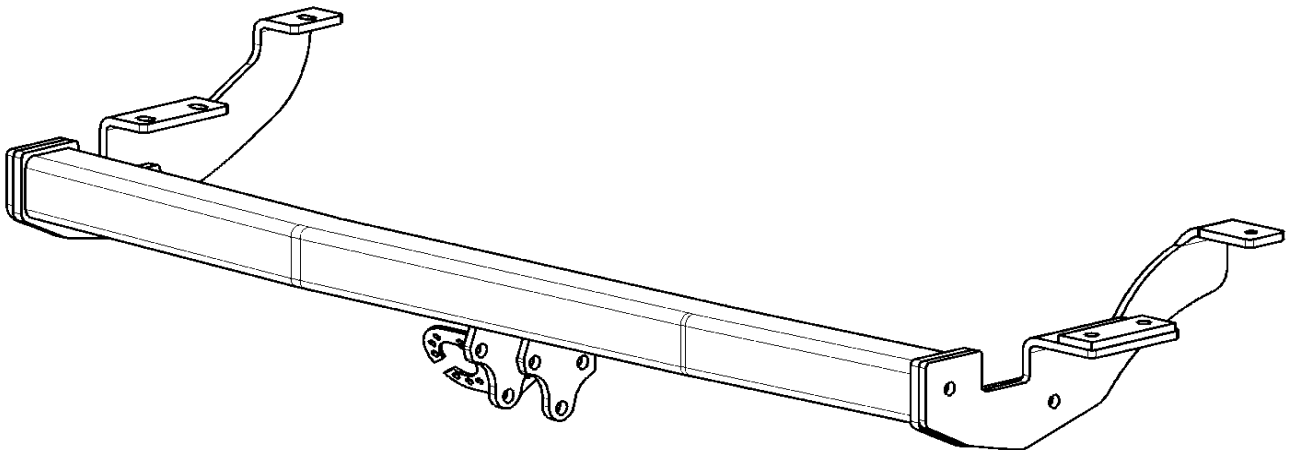
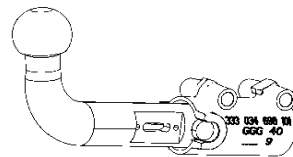

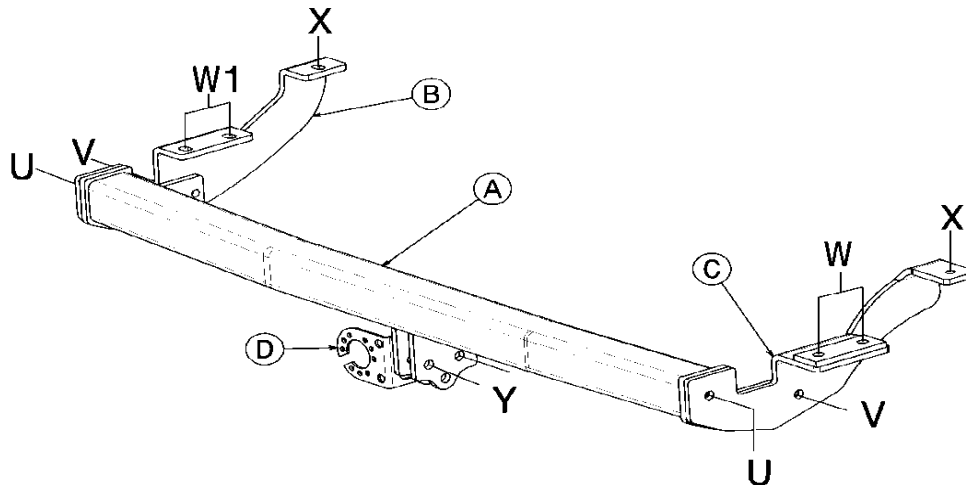











8,2 kN









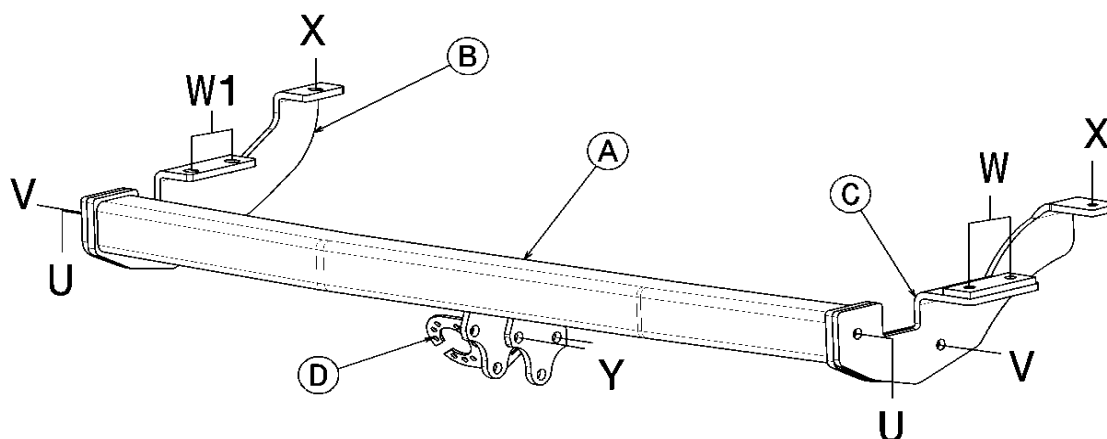







04-162





		CS 8	x 2
		HM8x20 - cl 8.8 - 20 Nm	x 2
<b>U</b>		HM10x35 - cl 8.8 - 40 Nm	x 2
		DEC10	x 2
<b>V</b>		HM10x35 - cl 8.8 - 40 Nm	x 2
		DEC10	x 2
		M10 - cl 8.8 - 40 Nm	x 2
<b>W</b>		HM10x50 - cl 8.8 - 40 Nm	x 2
		DEC10	x 4
		L 10/25	x 4
<b>W1</b>		HM10x40 - cl 8.8 - 40 Nm	x 2
<b>X</b>		HM8x30 - cl 8.8 - 20 Nm	x 2
		DEC8	x 2
<b>Y</b>		HM12x60 - cl 8.8 - 65 Nm	x 2
		DEC12	x 2
		M12 - cl 8.8 - 65 Nm	x 2
<b>Z</b>		HM16x40 - cl 8.8 - 170 Nm	x 2
		DEC16	x 2
		M16 - cl 8.8 - 170 Nm	x 2



		CS 8	x 2
		HM8x20 - cl 8.8 - 20 Nm	x 2
<b>U</b>		HM10x35 - cl 8.8 - 40 Nm	x 2
		DEC10	x 2
<b>V</b>		HM10x35 - cl 8.8 - 40 Nm	x 2
		DEC10	x 2
		M10 - cl 8.8 - 40 Nm	x 2
<b>W</b>		HM10x50 - cl 8.8 - 40 Nm	x 2
		DEC10	x 4
<b>W1</b>		L 10/25	x 4
		HM10x40 - cl 8.8 - 40 Nm	x 2
<b>X</b>		HM8x30 - cl 8.8 - 20 Nm	x 2
		DEC8	x 2
<b>Y</b>		HM12x60 - cl 8.8 - 65 Nm	x 2
		DEC12	x 2
		M12 - cl 8.8 - 65 Nm	x 2

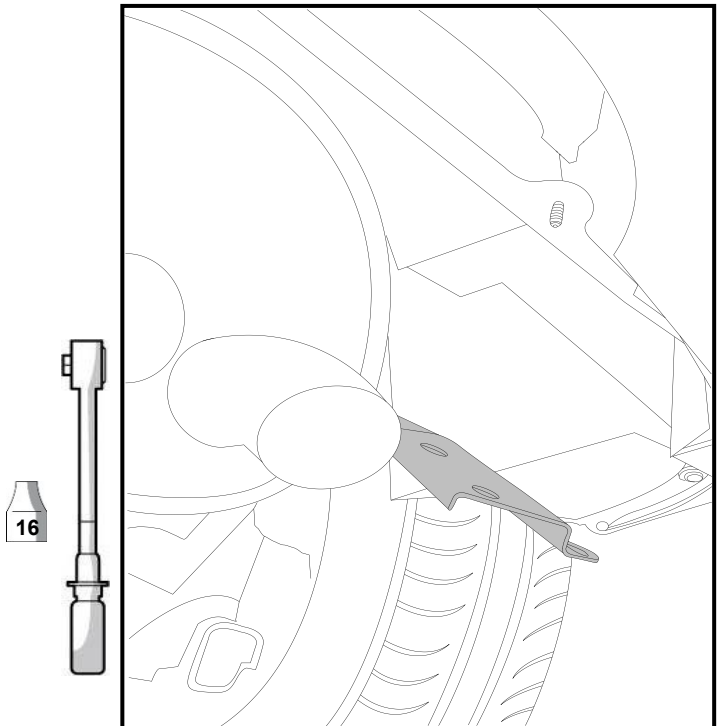
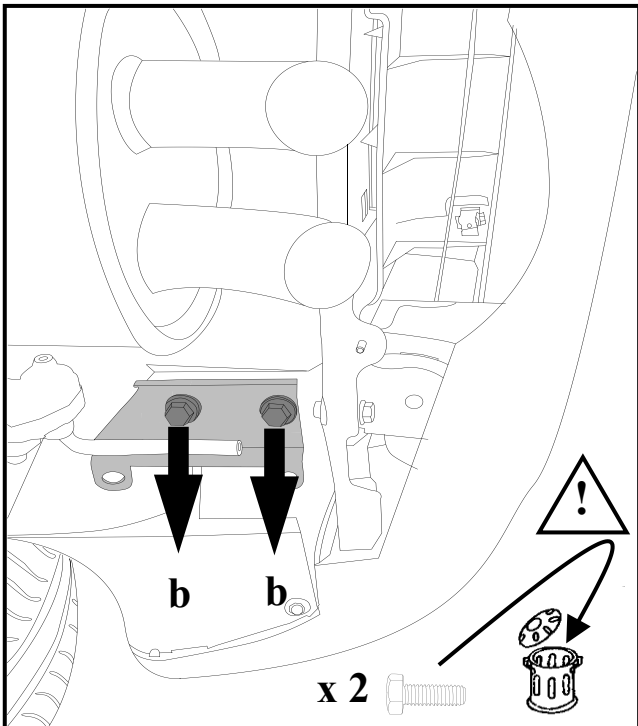
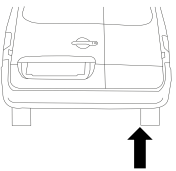
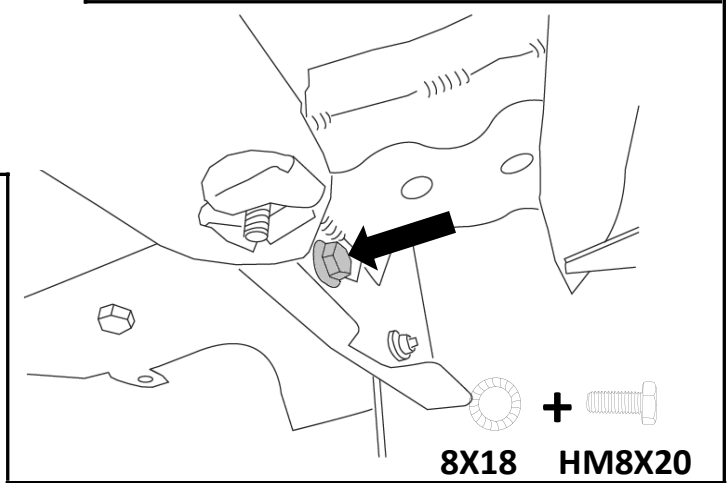
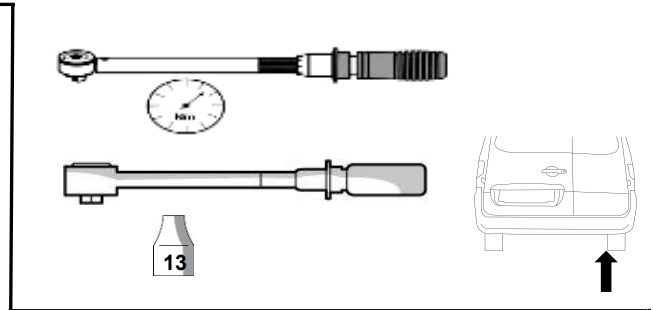
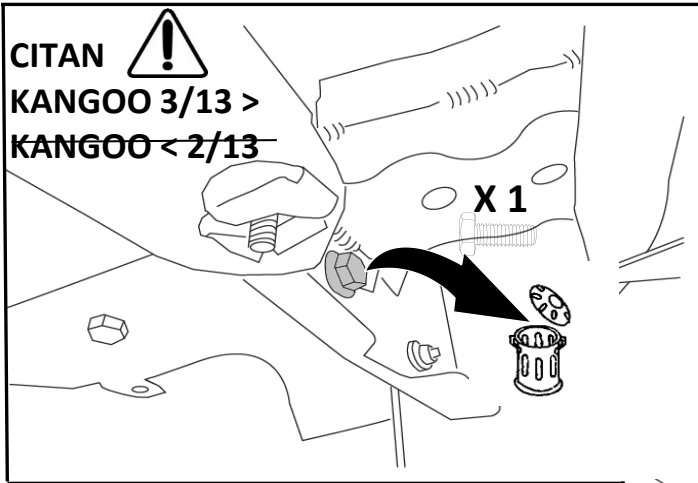
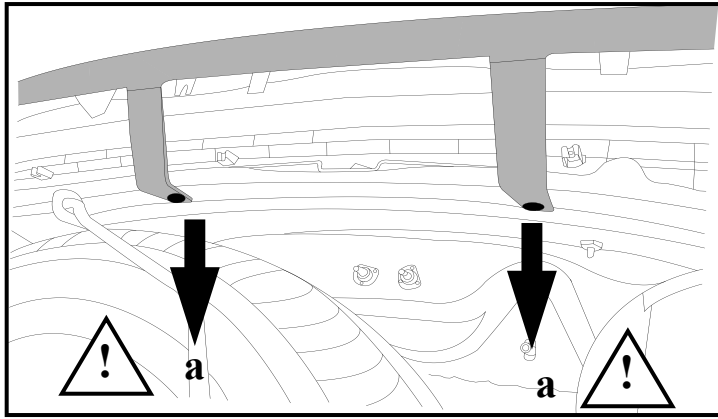
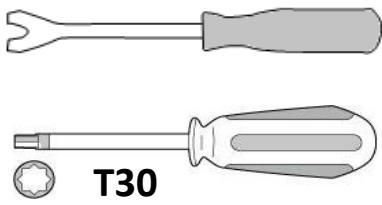

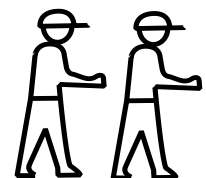
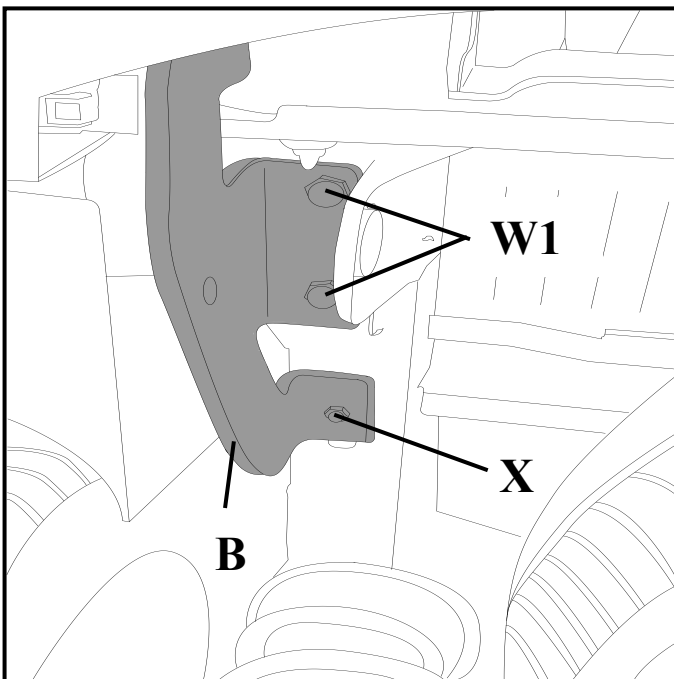
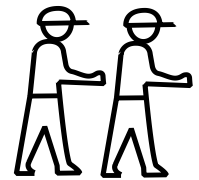
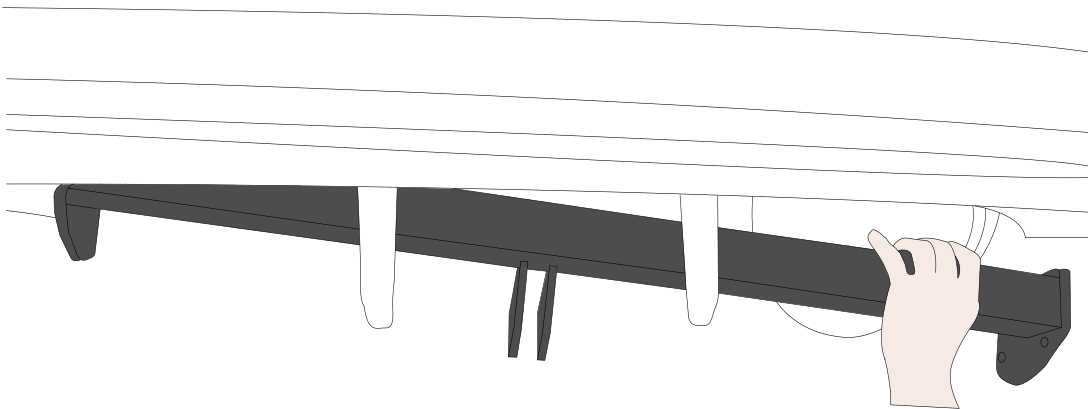
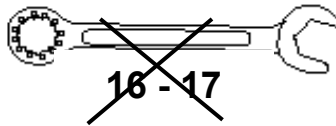
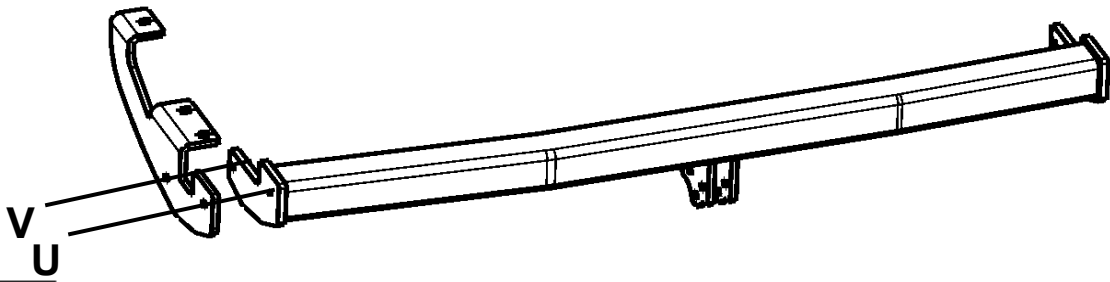

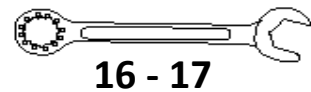
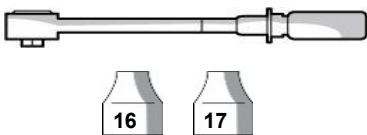
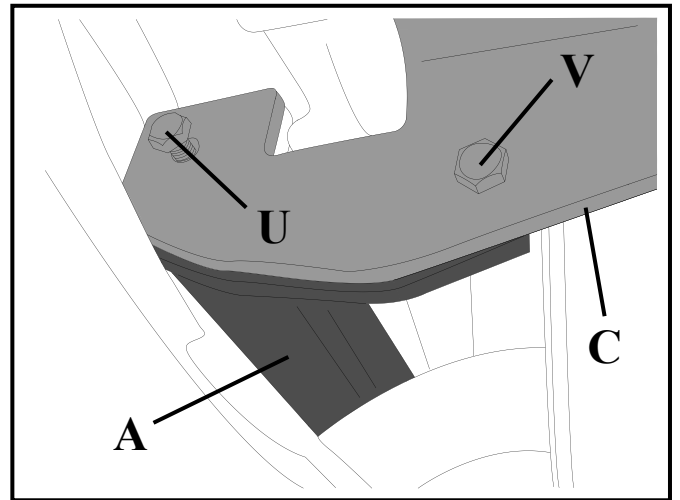
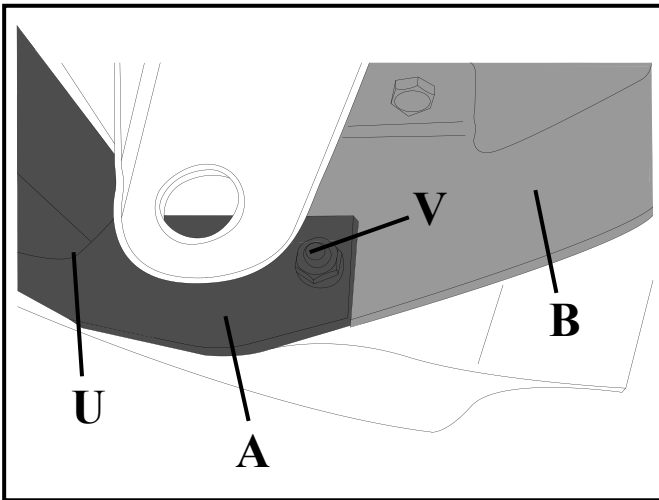
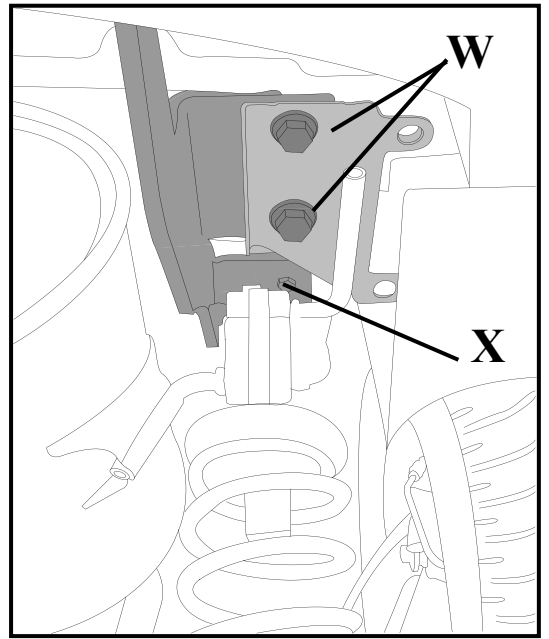
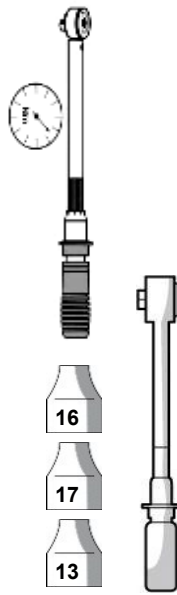
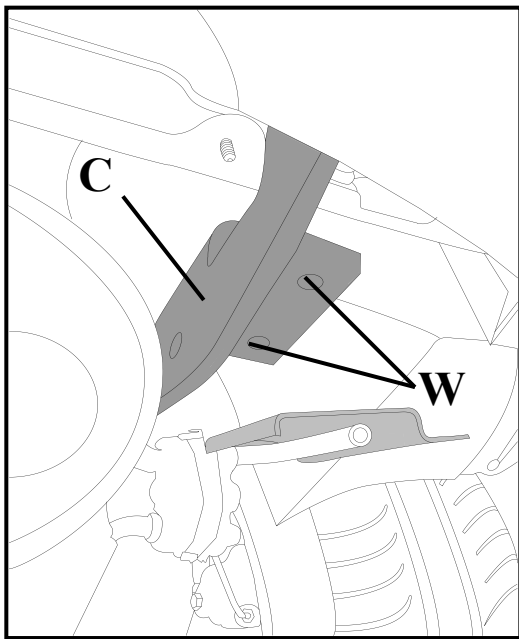
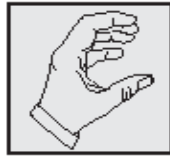
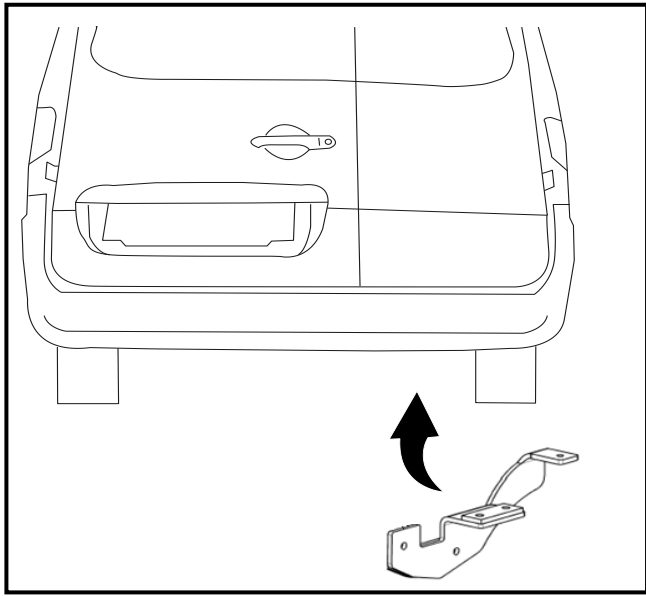



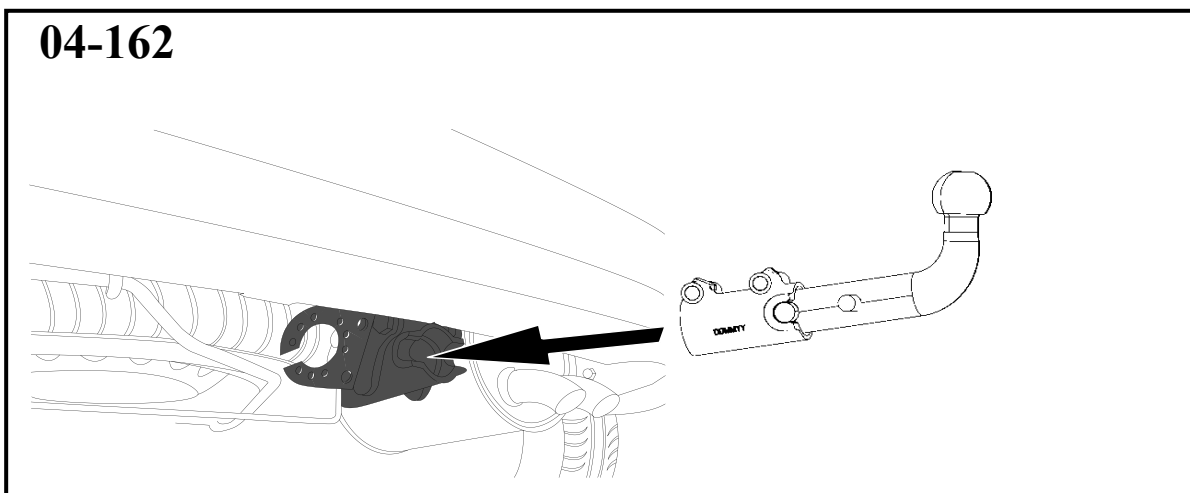
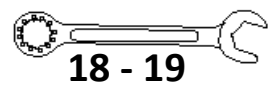
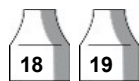
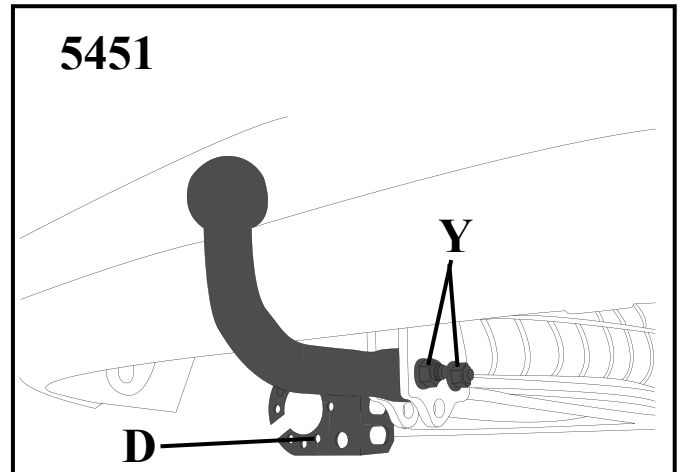
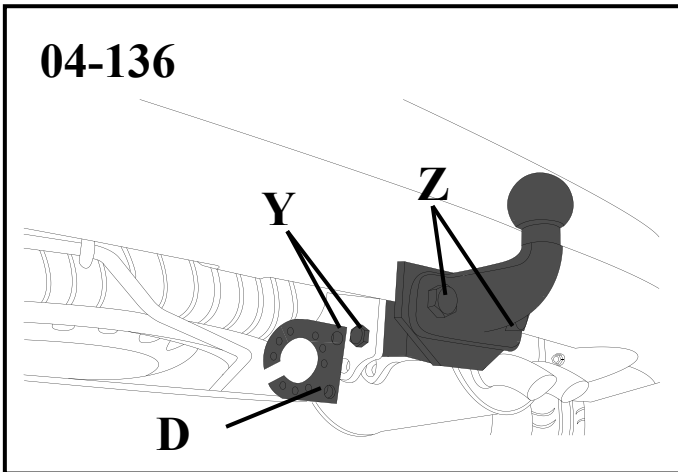
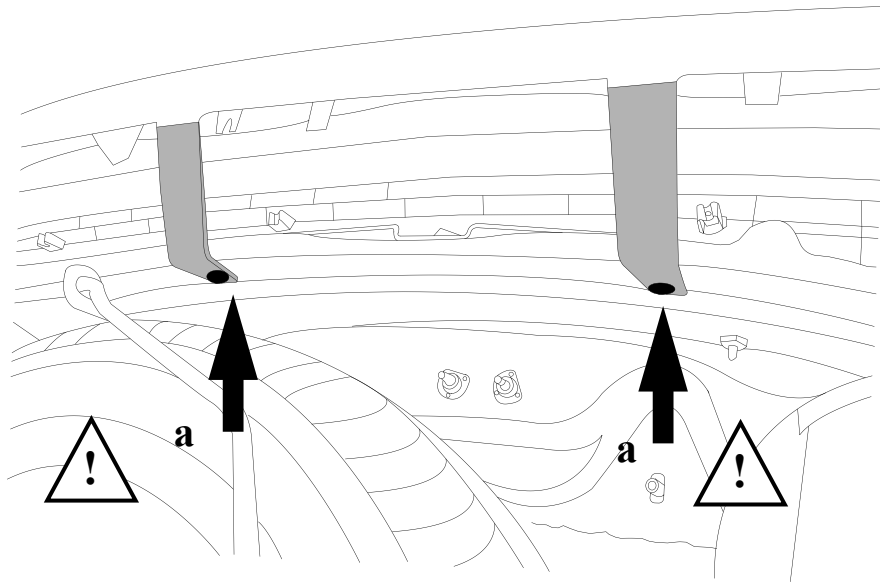

Dispositivo di traino tipo : **04 - 136 / 5451**  
Per autoveicolo : **Renault Kangoo II / Mercedes Citan**  
Tipo funzionale : **X61 (Kangoo) W415 (Citan)**



Classe e tipo di attacco : **A50-X**  
Omologazione : **e24\*94/20\*0103\*01**  
Valore D : **8,20 kN**  
Carico verticale max. S : **75 kg**  
Massa rimorchiabile : vedi carta di circolazione dell'autoveicolo

In base alla Direttiva europea 94/20, la massa massima rimorchiabile del dispositivo di traino è determinata dal valore di prova "D" così definito :

$$D = (T \times C) / (T + C) \times 0,00981 = 8,20 \text{ kN}$$

dove : T = Massa complessiva max. della motrice (in kg) e C = Massa rimorchiabile max. della motrice (in kg)

#### DICHIARAZIONE DI CORRETTO MONTAGGIO :

la sottoscritta Ditta dichiara che il dispositivo di traino tipo \_\_\_\_\_ è stato installato a regola d'arte, nel rispetto dei punti d'attacco e delle prescrizioni fornite dalla Casa costruttrice

sul veicolo \_\_\_\_\_

targato \_\_\_\_\_

il \_\_\_\_\_

Si dichiara inoltre di aver informato l'utente del veicolo sull'USO e MANUTENZIONE del dispositivo stesso.

timbro et firma

Dispositivo di traino tipo : **04 - 162**  
Per autoveicolo : **Renault Kangoo II / Mercedes Citan**  
Tipo funzionale : **X61 (Kangoo) W415 (Citan)**



Classe e tipo di attacco : **A50-X**  
Omologazione : **e24\*94/20\*0112\*00**  
Valore D : **8,20 kN**  
Carico verticale max. S : **75 kg**  
Massa rimorchiabile : vedi carta di circolazione dell'autoveicolo

In base alla Direttiva europea 94/20, la massa massima rimorchiabile del dispositivo di traino è determinata dal valore di prova "D" così definito :

$$D = (T \times C) / (T + C) \times 0,00981 = 7,19 \text{ kN}$$

dove : T = Massa complessiva max. della motrice (in kg) e C = Massa rimorchiabile max. della motrice (in kg)

#### DICHIARAZIONE DI CORRETTO MONTAGGIO :

la sottoscritta Ditta dichiara che il dispositivo di traino tipo \_\_\_\_\_ è stato installato a regola d'arte, nel rispetto dei punti d'attacco e delle prescrizioni fornite dalla Casa costruttrice

sul veicolo \_\_\_\_\_

targato \_\_\_\_\_

il \_\_\_\_\_

Si dichiara inoltre di aver informato l'utente del veicolo sull'USO e MANUTENZIONE del dispositivo stesso.

timbro et firma